

SÄND IN DIN ORDER TILL OSS VIA FAX ELLER
POST

Genoa/Fock

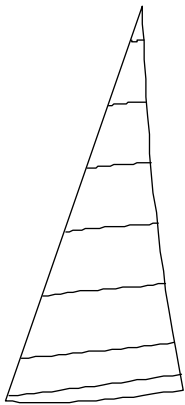

1

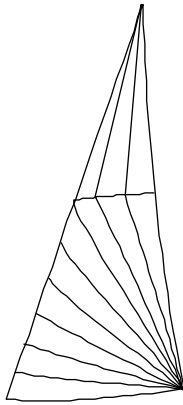

2

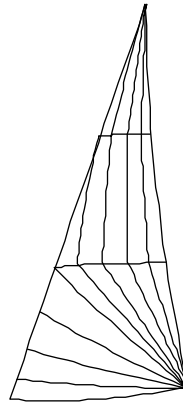

3

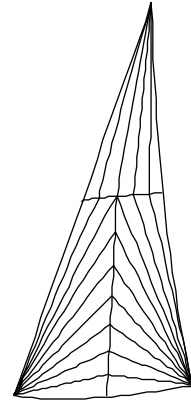

4

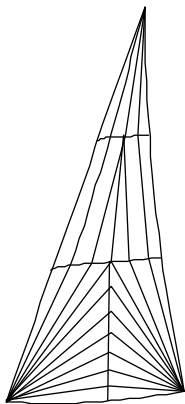

5

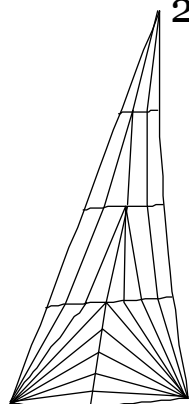

6

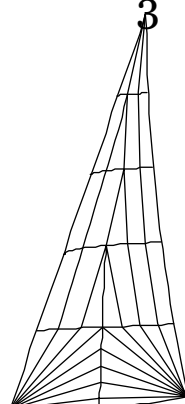

7

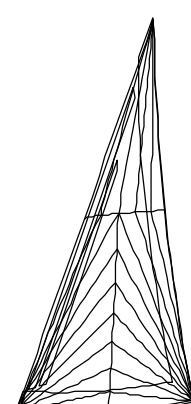

8

| | |
|--|--------------------------|
| Namn | |
| Adress | |
| Postnr | |
| Ort | |
| Tel | |
| Mobil | |
| E-post | |
| | |
| Battyp(T.ex.B-31) | |
| Löa | |
| Bredd | |
| Deplacement | |
| Arsmodell | |
| | |
| Hur kategoriserar du dig som seglare? | |
| <input type="checkbox"/> | Fritidssegelare |
| <input type="checkbox"/> | Klubbkappsegelare |
| <input type="checkbox"/> | Tävlingssegelare |
| | |

**Fortsätt att fylla i
formulären
på nästa sida.**

Fyll i så mycket du kan

SÄND IN DIN ORDER TILL OSS VIA FAX ELLER POST

Genoa/Fock

| | |
|-----------------------------------|--|
| Bat typ | |
| Arsmodell | |
| Löa | |
| Deplacement | |
| Rig typ – masthead(ja/nej) | |
| Rigtyp – partiall(ja/nej) | |
| T | |
| LP | |
| J | |
| Skärning | |
| Duktyp | |
| Rullprofil-ange "O" | |
| Rullprofil-ange "G" | |
| UV-skyddets färg | |
| Bukkompensator(ja/nej) | |
| ÖVRIGT MEDDELANDE/INFO | |

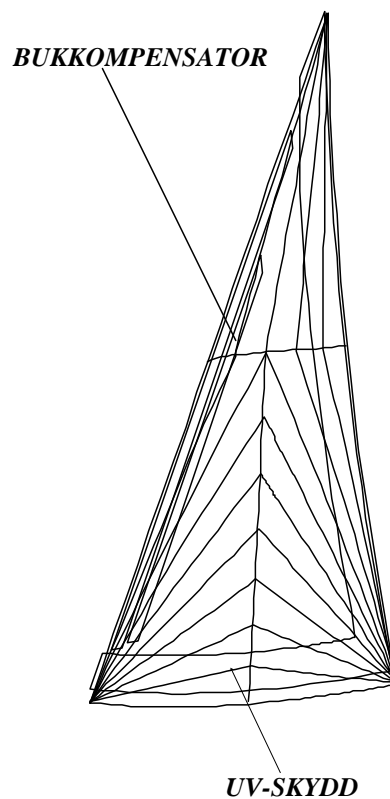

SÄND IN DIN ORDER TILL OSS VIA FAX ELLER POST

Genoa/Fock

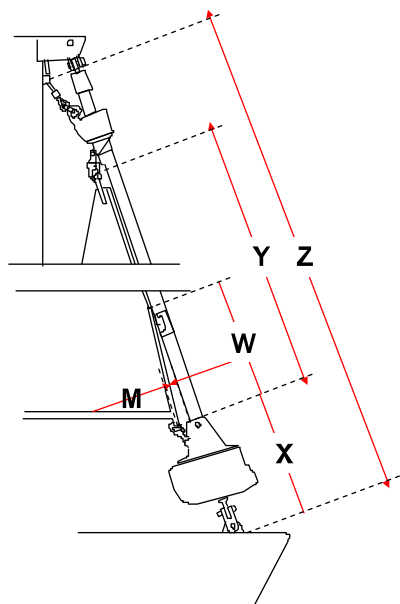

| | |
|----|--|
| AL | |
| B | |
| C | |
| D | |
| E | |
| F | |
| I | |
| J | |
| K | |
| LP | |
| M | |
| O | |
| R | |
| UL | |
| W | |
| T | |
| X | |
| Y | |
| Z | |

